

ESQUEMATICO ZX SPECTRUM 48kB ISSUE 6A

Retrocomputing

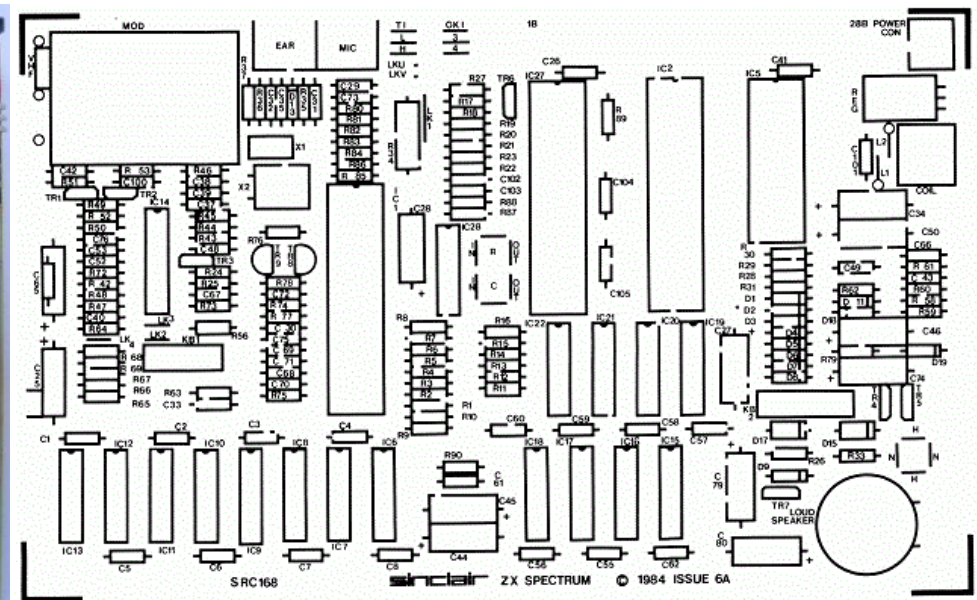

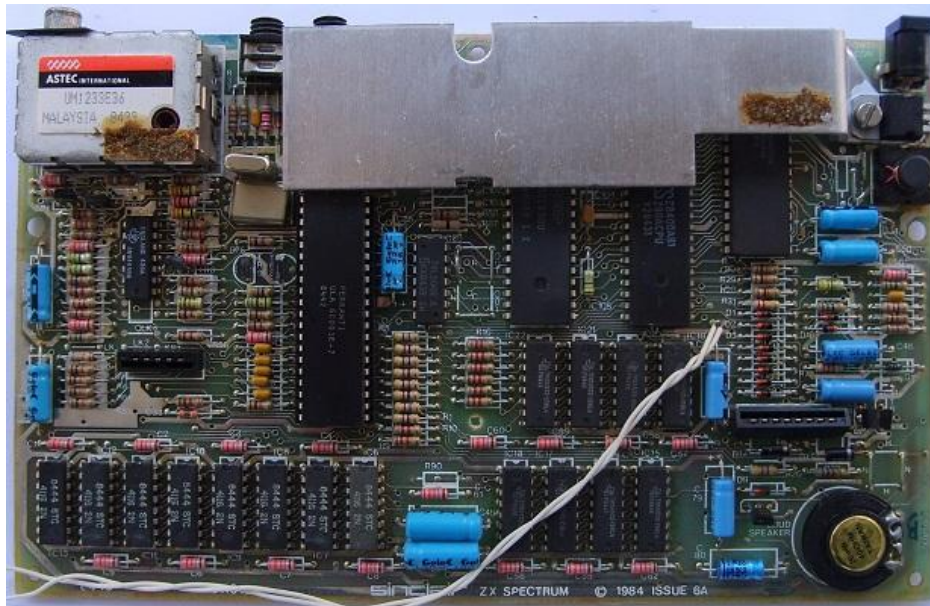
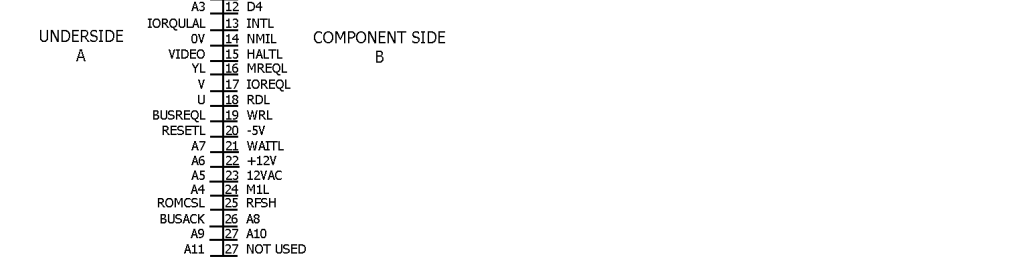
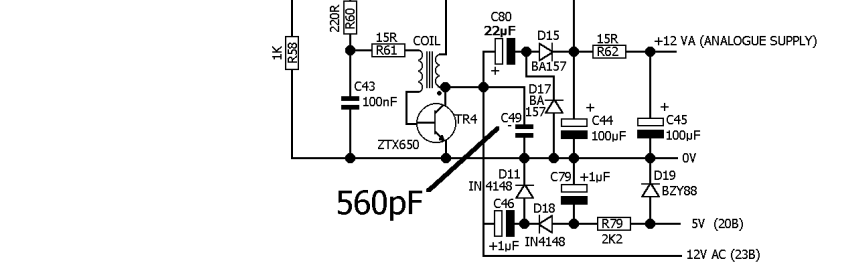
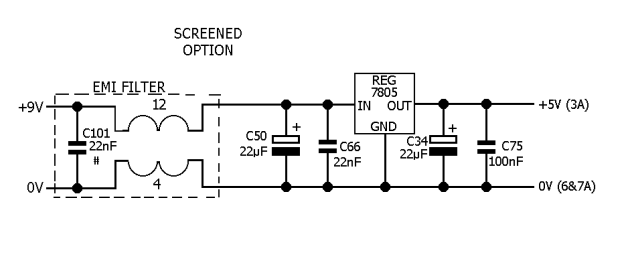
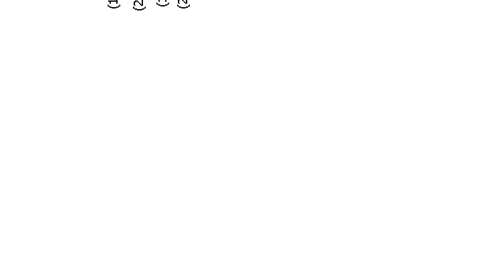
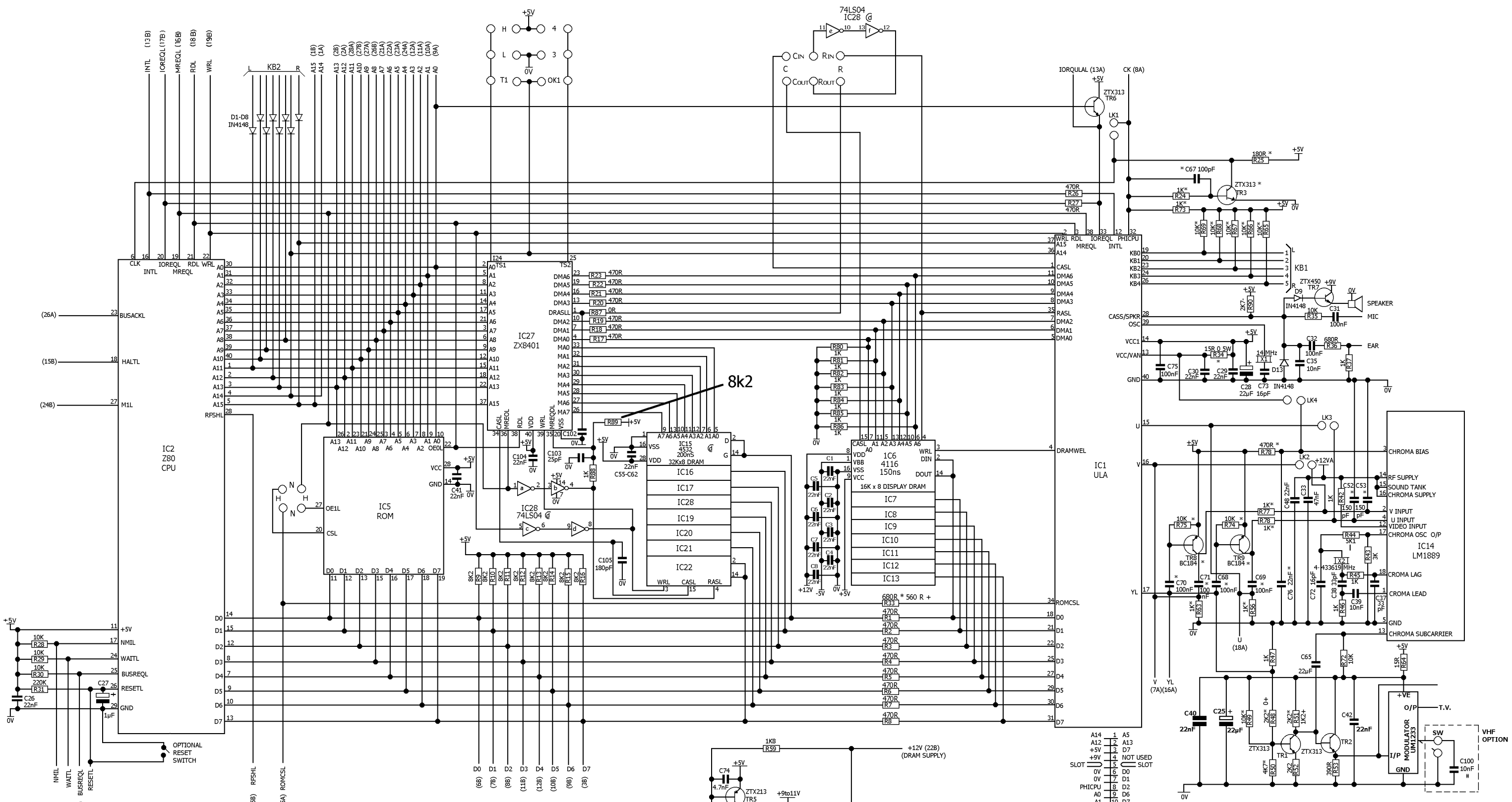

A14	1	A5
A12	2	A13
+5V	3	D7
+9V	4	NOT USED
SLOT	5	SLOT
0V	6	DO
0V	7	D1
PHICPU	8	D2
A0	9	D6
A1	10	D7
A2	11	D3
A3	12	D4
IORQUAL	13	INTL
0V	14	NMIL
VIDEO	15	HALTL
YL	16	MREQ
V	17	IOREQ
U	18	RDL
BUSREQ	19	WRL
RESETL	20	5V
A7	21	WAITL
A6	22	+12V
A5	23	12VAC
A4	24	M1L
ROMCSL	25	RFSHL
BUSACK	26	A8
A9	27	A10
A11	27	NOT USED